

省配線端子台規範

DSSXY8L-C 設計規範

示意圖 - 背面底座

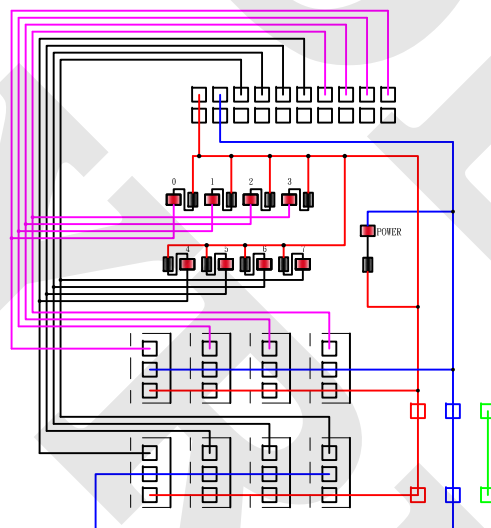
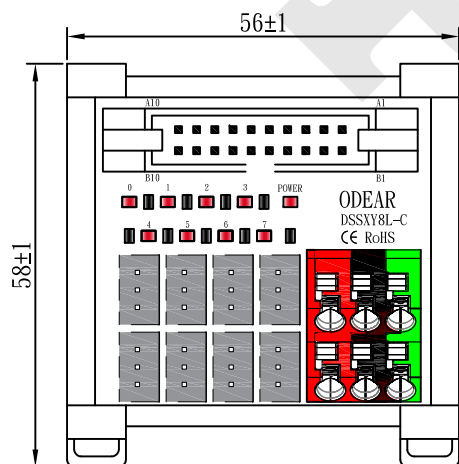
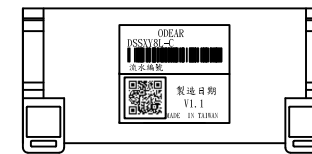

一、魔力設計端子台

1. 紅: 正電24V
2. 黑: 負電0V
3. 綠: 接地

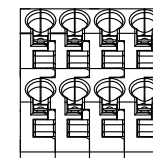

- 快速接頭 腳位定義:
1. 訊號 (0~F)
 2. DC (-24V)
 3. DC (+24V)

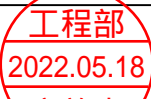
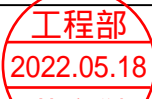
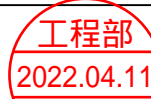

詳細功能請參照說明手冊

REV	DESCRIPTION	DATE	承認	審核	繪圖	客戶P/N	日期	2022/01/14	 歐迪爾股份有限公司 O-DEAR INTERNATIONAL CORP.
1.0	Original Release	2019/07/29	 工程部主任 2022.05.18 廖啓志	 工程師 2022.05.18 薛宇傑	 工程師 2022.04.11 白佳弘				
1.1	版面更新	2022/01/14							